

# Series II Wall Console Installation Instructions

## TOOLS REQUIRED

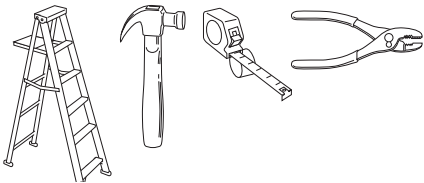

## OPTIONAL TOOLS REQUIRED



## OPERATION AND FEATURES.

Wall console has 3 buttons and 1 indicator backlight.

### Backlight

Indicator backlight will display red when wall console is properly wired and Sure-Lock™ is OFF. When Sure-Lock™ is ON, indicator backlight will be OFF.

### Open/Close Button

This button opens and closes garage door. When Sure-Lock™ is ON, the Open/Close button will CLOSE door only.

NOTE: Constant button pressure in the CLOSE mode will override STB error responses in the powerhead and close door.

### Independent Light Console Button

Use this button to turn powerhead lights ON. Powerhead lighting will remain ON until this button is pressed again or a door action has been completed. Note: *If opener has a Motion Detector, the sensor will keep the powerhead lights ON as long as motion is detected.*

### Sure-Lock™ Switch

When Sure-Lock™ is ON and the garage door is in the fully closed position, the powerhead cannot be activated by the wall console or a remote. Note: *If Sure-Lock™ is activated while the garage door is not fully closed, the door can still be operated until the door is in the fully closed position.*

- Slide the Sure-Lock™ Switch up to activate it. The backlight will be OFF.
- Slide the Switch down to turn Sure-Lock™ OFF. The backlight will be ON.

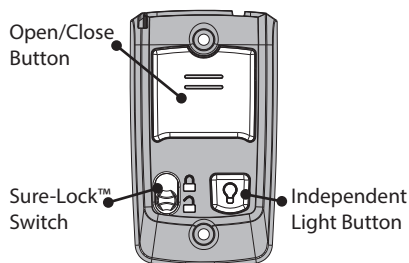

## ⚠ WARNING

**Moving Door can cause serious injury or death.**



- Wall console must be mounted in sight of the door at least 5 feet above floor and clear of moving door parts.
- **Keep people clear** of opening while door is moving.
- **Do Not** allow children to play the remote or door opener.

If safety reverse does not work properly:

- **Close door then disconnect opener** using the manual release handle. **Do Not** use remote or door opener.
- Refer to door and door opener owners manuals before attempting any repairs.

**Electrical Shock can cause serious injury or death.**



- Power cord must be unplugged before attaching any wires.
- Be sure wire ends do not touch each other or other terminals.

If you have any questions or if you need a manual, contact the distributor or manufacturer or the opener.

## ⚠ AVERTISSEMENT

**Toute porte en déplacement peut entraîner des blessures graves voire mortelles.**



- La console murale doit être installée en vue de la porte, à au moins 1,5 m au-dessus du sol et à l'écart des pièces de la porte mobiles.
- **Ne laisser personne se tenir dans** l'ouverture de la porte pendant qu'elle est en mouvement.
- **Ne pas** permettre aux enfants de jouer avec les télécommandes ou l'ouvre-porte.

Si le système de sécurité à l'inversion ne fonctionne pas correctement :

- **Fermer la porte puis débrancher l'ouvre-porte** en utilisant la poignée de déverrouillage manuel. Ne pas utiliser la télécommande ni l'ouvre-porte.
- Se reporter aux manuels de la porte et de l'opérateur de l'ouvre-porte avant de tenter toute réparation.

**Une décharge électrique peut provoquer des blessures graves ou mortelles.**



- S'assurer que le cordon d'alimentation est débranché avant de raccorder les fils.
- Les extrémités des fils ne doivent pas se toucher entre elles ou toucher aucune autre borne.

Si vous avez des questions ou si vous avez besoin d'un manuel, contactez le distributeur ou le fabricant de l'ouvre-porte automatique.

## ⚠ WARNING

Verify there is NO power to the opener before installing wall console and/or wall console wires.

## ⚠ AVERTISSEMENT

Vérifier que l'ouvre-porte n'est pas sous tension avant d'installer la console murale et/ou les fils de la console murale.

## ⚠ CAUTION

Use only Genie® Brand Wall Consoles. Others could cause unexpected door operation.

## ⚠ ATTENTION

Utiliser uniquement des consoles murales Genie®. Les consoles d'une autre marque pourraient provoquer un fonctionnement inattendu de la porte.

## Wall Console Replacement

### Using Previously Installed Wiring

Need to install new wire? Wire (P/N 35265A.S), can be purchased through Customer Service at 1-800-35-GENIE or from your local Genie® Dealer.

### INSTALLING REPLACEMENT WALL CONSOLE

- Disconnect power to powerhead.
- Remove existing wall console from the wall by removing mounting screws. • Remove wires from existing wall console.
- Split and strip ends of wire if required (Fig. 2).

FIG. 2.

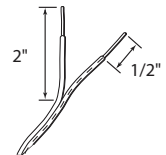

- Fasten wire to control board screws on back of wall console (Fig. 3):

FIG. 3.

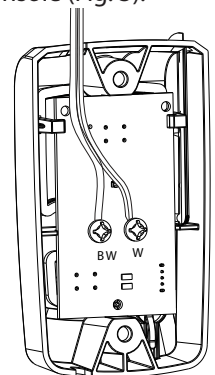

- Connect white wire between powerhead terminal #3 to wall console terminal "W." (Fig 3 & 7).
- Connect striped wire between powerhead terminal #4 to wall console terminal "B." (Fig 3 & 7).

**NOTE:** When existing wires have a color code different from above (FIG. 3), or none at all—make sure the wires are connected between terminals as directed above. When the wires are connected to the opposite terminals, the Sure-Lock® and Light feature may not function. The first indication of incorrect wiring is the backlight will be OFF.

- Mount wall console to wall using screws provided. Verify height at least 5 ft. above floor (Fig. 4).

**Reconnect power to powerhead.**

- Check operation of each wall console button and feature.

FIG. 4.

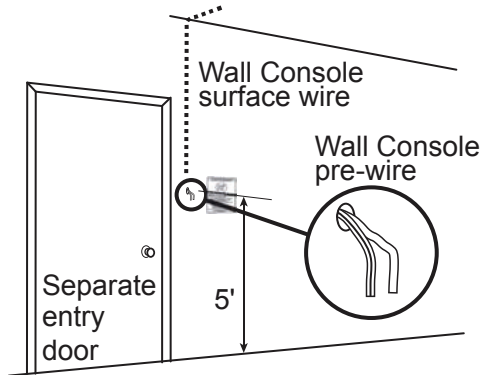

### Wall Console Replacement Using New Wiring

**NOTE:** IF MOUNTING CONSOLE IN A NEW LOCATION THAT LOCATION MUST MEET THE FOLLOWING CRITERIA:

- within sight of garage door,
- at least 5 ft. above floor (out of small children's reach) and,
- away from all moving parts of the garage door.

**DISCONNECT POWER TO POWERHEAD.**

- Remove existing wall console from the wall by removing mounting screws.
- Split and strip ends of wire (Fig. 2).
- Fasten wires to control board screws on back of wall console (Fig. 3).
- Remount wall console.
- Route wire from wall console to powerhead.
- As you run wire, securely fasten wires to ceiling and wall using insulated staples (Fig. 5). Not provided.

**Staples should be snug only.**

- Route wire through wire guide as shown in Fig. 6 to the terminals.
- Split and strip ends of wire (Fig. 2).
- Connect white wire between powerhead terminal #3 to wall console terminal "W." (Fig 3 & 7).
- Connect striped wire between powerhead terminal #4 to wall console terminal "B." (Fig 3 & 7).
- While pressing in locking tab, insert wire into terminal hole and then release locking tab. Confirm secure connection with a gentle tug. (Fig. 7).

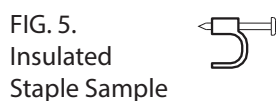

### CAUTION

Staples which are too tight can cut or pinch wires.  
Cut or pinched wires can cause the wall console to stop working. When using the insulated staples, make sure you fasten them only as tightly as needed to hold the wire snugly.

### ATTENTION

Des agrafes trop serrées peuvent pincer ou couper les fils.  
Les fils coupés ou pincés peuvent interrompre le fonctionnement de la console murale. Lors de l'utilisation d'agrafes isolées, toujours attacher les fils solidement mais sans excès.

FIG. 6.

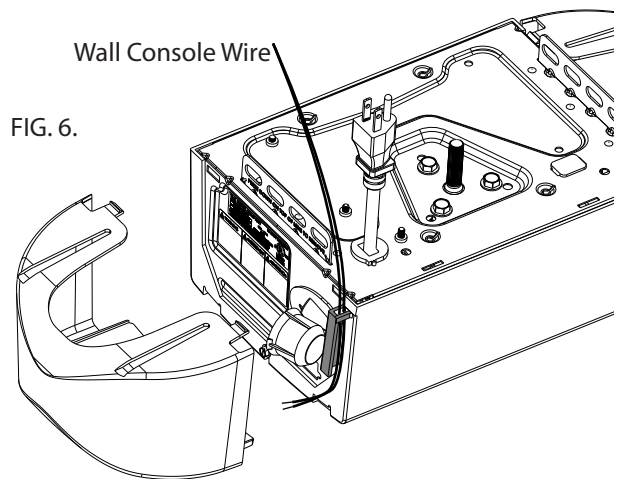

Wire Routing Tube (most models)  
Sample Shown, Your model may differ.

FIG. 7.

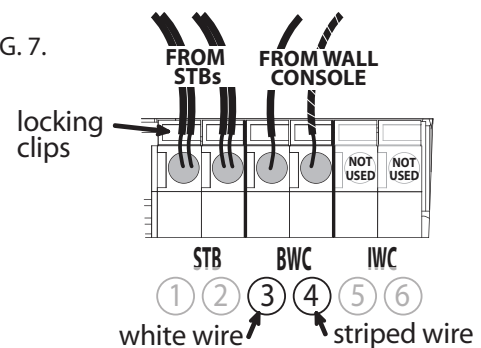

**NOTE:** Make sure the wires are connected between terminals as directed above. When the wires are connected to the opposite terminals, the Sure-Lock® and Light feature may not function. The first indication of incorrect wiring is the backlight will be OFF.

**NOTE:** FOR CONNECTION TO MODELS NOT SHOWN—SEE YOUR OWNERS MANUAL.

**RECONNECT POWER TO POWERHEAD.**

- Check operation of each button and feature.